

# BIANCO® PUMPZ

## Pumps

### *INOX*

INOX45 808393

INOX60 808394

INOX90 808395

### *FERRO*

FERRO60 808397

### *PTF*

PTF 808396



# 1. Introduction

Congratulations on your purchase of Bianco Pumpz pump.

Bianco Series 2 offers performance, reliability and dependability.

This manual is for the Jet types Inox (stainless steel) and Ferro (cast iron) pumps as well as for the PTF (peripheral turbine type) model.

- **Inox:**  
Corrosion resistant stainless steel housing with reinforced composite internals
- **Ferro:**  
Cast iron housing with cathodosis corrosion resistant coating and reinforced composite internals

*The Inox and Ferro pump models are ideal for supplying water to domestic installations and applications where some suction lift is necessary*

- **PTF:**  
Cast iron housing with cathodosis corrosion resistant coating and stainless steel impeller

Bianco Inox and Ferro S2 Jet pumps incorporate an internal venturi enabling water to be drawn from below ground level. Your pump is equally comfortable pumping from a tank, boosting low pressure water supply or working in conjunction with a rainwater changeover device.

PTF peripheral turbine pumps are best suited to 'flooded suction' type applications as they lack the ability to self-prime.

With the aim of getting you up and running smoothly all BiancoS2 pumps are supplied with a pre-wired iCon nXt electronic pressure controller which doesn't require a licensed electrician to install.





# 2. Key Features

- Includes iCon nXt electronic pump controller for automatic pump starting, stopping and restart after power loss and/or water loss
- Pump control fitted and wired with plug and play leads so a licensed electrician is not required during installation
- Pump controller pre-set to start once the pressure falls below 2.2bar
- Incorporates run-dry (low flow) protection to prevent pump damage
- High quality mechanical shaft seal and high quality motor bearings
- 240V single phase TEFC motor with in-built auto reset thermal overload to prevent the pump from overheating



### 3. Contents

1. Introduction .....	2
2. Key Features.....	2
3. Contents .....	3
4. ISO 7010 Symbols used in this manual .....	3
5. Warnings.....	4
5.1 Cautions.....	5
6. Standards and Approvals .....	5
7. Technical Specifications.....	6
8. Electrical Connections.....	7
9. General installation notes.....	8
10. General intake (suction) piping notes.....	9
11. Boosting mains supply or connecting to a hot water system.....	10
12. Water supply above the pump inlet (flooded suction).....	11
13. Water supply below the pump inlet (suction lift) .....	12
14. Priming and Operation.....	13
15. Warranties – Terms and Conditions .....	14
16. Trouble Shooting Guide.....	15

### 4. ISO 7010 Symbols used in this manual

	Warning - Electrical safety
	Warning – Potential consequences of use outside of intended application(s). Includes environmental condition warnings.
	Mandatory warning
	Warning to disconnect power
	Read carefully



## 5. Warnings

	<p>Read the manual carefully before starting and retain for future reference.</p>
	<p>Prior to starting installation or any maintenance the pump must be disconnected from the power supply and pressure relieved from the system including controller, pump and associated pipework.</p>
	<p>Any changes or modification to the wiring must be carried out by suitably qualified personnel.</p>
	<p>A qualified electrician should correctly size and install circuit breakers to protect the power supply. The fitment of additional surge protection is recommended.</p>
	<p>Never open the controller cover or pump terminal box cover while controller is connected to electrical supply.</p>
	<p>This appliance is not intended for use by persons (including children) with reduced physical, sensory or mental capabilities, or lack of experience and knowledge, unless they have been given supervision or instruction concerning use of the appliance by a person responsible for their safety. Children should be supervised to ensure that they do not play with the appliance.</p>
	<p>To avoid excessive thermal shock to the motor the pump should not start more than 20 times in any one hour period.</p>
	<p>Ensure that the installation will comply with all applicable local regulations.</p>

## 5.1 Cautions

- 5.1.1 Protect the pump and controller from rain and moisture and minimise exposure to extremes of heat and cold. Operating range 2°C - 40°C.
- 5.1.2 The pump is designed for use with clean water. Contamination including sand or mineral deposits may affect the operation of the pump and controller.
- 5.1.3 The pH of the water must be between 6.5 and 8.5.
- 5.1.4 This pump is not suitable for use with spa or pool water.
- 5.1.5 Running the pump without water or allowing the pump to run dry will damage the mechanical seal and void the warranty.
- 5.1.6 Avoid situations where the pump could be exposed to corrosive liquids or gasses, or to flammable materials, solvents etc.
- 5.1.7 Fitment and replacement must be carried out by competent, skilled and qualified personnel.

## 6. Standards and Approvals

	<p><b>SAA Approvals</b> is accredited by the Joint Accreditation Service of Australia and New Zealand (JAS-ANZ) as a third party certification body to issue of Certificates of Approval for declared and non-declared electrical equipment that has proven to comply with the safety requirements of the applicable Australian Standard.</p>
	<p>Pumps that carry the <b>AS/NZ4020 Drinking Water Approval</b> demonstrate compliance with requirements of Australia &amp; New Zealand Standards of products that come into contact with water intended for human consumption. This approval also ensures that the water coming from the pump will not be contaminated by toxic materials or metals. It also means the water will not support the growth of micro-organisms and will not cause a change in taste or appearance.</p>
	<p><b>CE marking</b> is a certification mark that indicates conformity with health, safety and environment. The CE marketing represents a manufacturer's declaration that products comply with the EU's New Approach Directives. These directives not only apply to products within the EU but also for products that are manufactured in or designed to be sold in the EEA.</p>

## 7. Technical Specifications

### SPECIFICATIONS

ITEM CODE	808393	808394	808395	808397	808396
	INOX45S2NXT	INOX60S2NXT	INOX90S2NXT	BIA-FERRO60NXT	BIA-PTF37NXT
Maximum head	40m	43m	50m	45	45
Maximum flow	50 lpm	58 lpm	70 lpm	58 lpm	37 lpm
Pump Start pressure	Preset 2.2 bar				
Pump stop	Flow less than 0.5 lpm				
Input power	220 (-6%) - 240V (+6%) 1ph 50Hz			220 (+4%) - 240V (+6%) 1ph 50Hz	
Motor	Asynchronous TEFC motor with in-built auto reset thermal overload				
IP Rating / Insulation	Ingress Protection - IPX4 / F Class Motor Insulation				
Motor Rating (KW)	0.45kW	0.6kW	0.9kW	0.6kW	0.37kW
HP	0.6hp	0.8hp	1.2hp	0.8hp	0.5hp
Max Amperage	3.5 amps	4 amps	6 amps	4.5 amps	2.5 amps
Start Capacitor	10 uF	16 uF	25 uF	12 uF	8 uF
Pump materials	Pump body: Stainless Steel 304 Jet/Venturi, Diffuser, Impeller: Noryl Glass Reinforced O Rings: Nitrile			Cast Iron HT200	Cast Iron
Mechanical Seal	Carbon/Ceramic/Nitrile				
Inlet/Outlet Size	Suction 1" BSPF / Discharge 1" BSPM				
Pressure Tank	2 - 18 litre recommended for most efficient operation				
Maximum pressure	6 bar			8 bar	6 bar
Working temp range	2 - 40°C				
Power Cable	2m long 10 amp rated H05 flex with AS/NZ 3112 (Type I) 3 pin male power plug				
Weight	10 kg	12.5 kg	14 kg	18 kg	6.5 kg

## 8. Electrical Connections

Always use an electrical outlet that is protected by Residual Current Device (RCD) Safety Switch with a trip current of 30mA or less. A Safety Switch is required by Australian/New Zealand Standard AU/NZS 60335.1-2011.



The pump is supplied with a 10 amp rated lead and AS/NZ 3112 (Type I) 3 pin male power plug for connecting to mains power.

Exercise care with the power cord. Route the cord carefully to avoid potential snagging or chafing hazards. Never lift the pump by the power cord or disconnect from the power supply by pulling the cord.

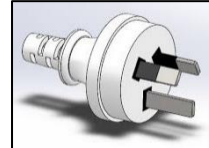
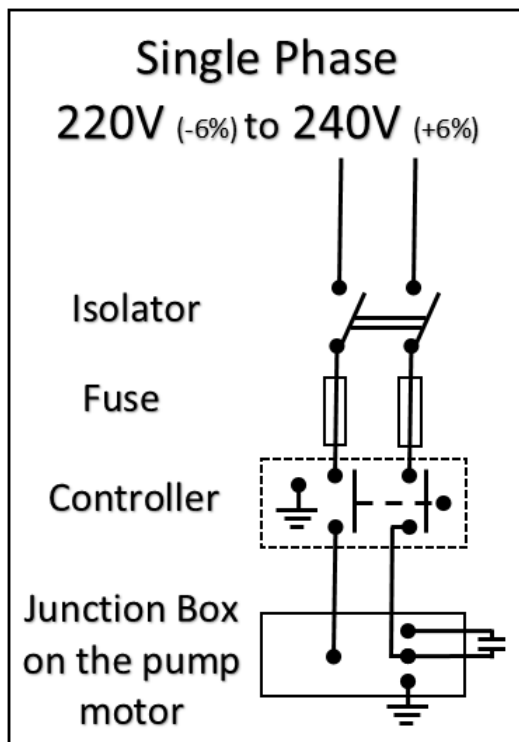

## 9. General installation notes



### Review Section 5 - Warnings and 5.1 - Cautions prior to installing

Choose a pump location with a firm base as close to your water source as possible and close to a suitable power supply.



Avoid extension cords. If an extension cord must be used ensure it is correctly rated.

The pump should be housed in a weather proof, free draining, well vented enclosure to protect it from the extremes of temperature, moisture, flooding, chemicals, vermin and insects, dust etc.



Before installation, inspect the pump for any shipping damage.

If solid fittings are used to connect to the pump ensure the pump is mounted securely on a concrete tile, concrete base or similar. If the pump is not mounted securely then flexible piping connectors are recommended.



Avoid strain on the pump casing by supporting your pipework.

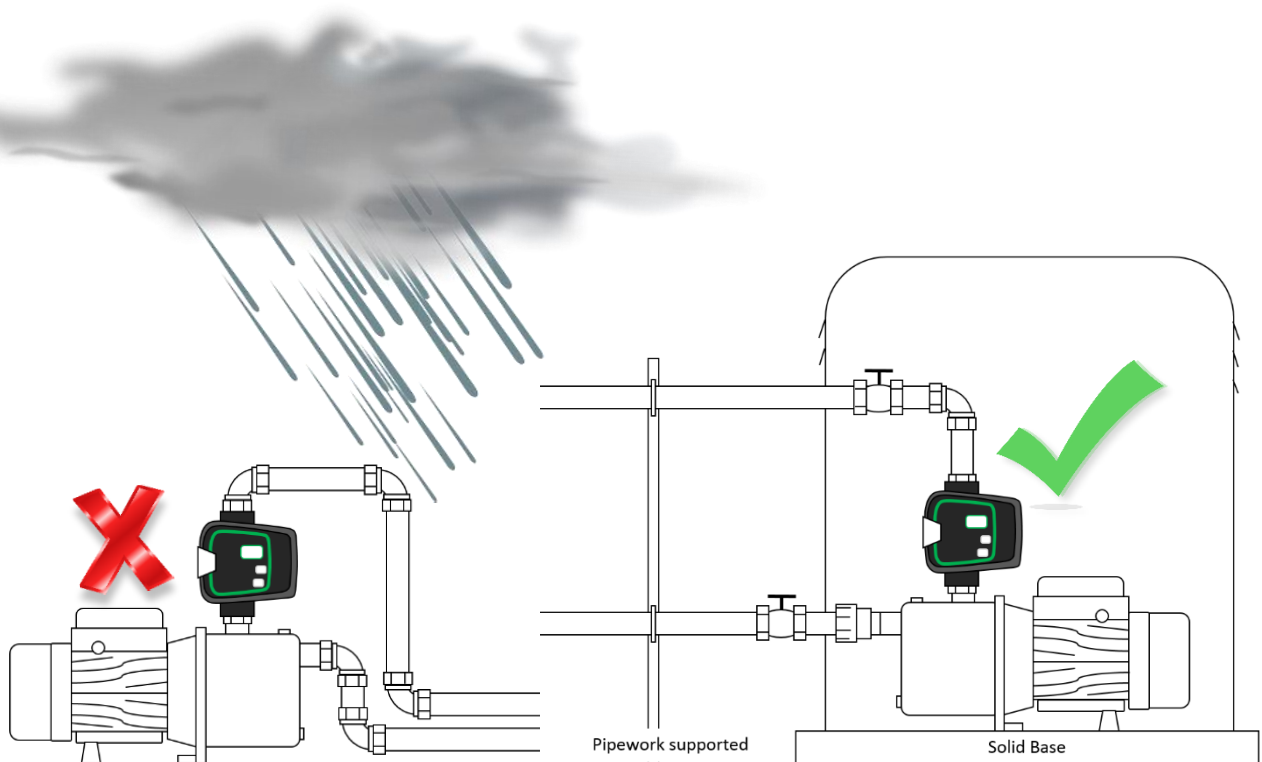



## 10. General intake (suction) piping notes

The intake suction piping is the most critical part of the installation. Errors or air leaks will cause significant issues for performance and pump reliability.



### Reminders of best practice:

Pipe size must be equal to or larger than the inlet port size (see Section 13)

Inlet piping as short and straight as practical

Avoid bends within 150mm of the inlet port

Avoid pipework which results in air pockets

Connection to the pump using unions ensures easy removal for servicing

If the water supply is above the pump inlet, fit an isolating valve close to the pump

A gate valve on the pump discharge will aid diagnosing system problems

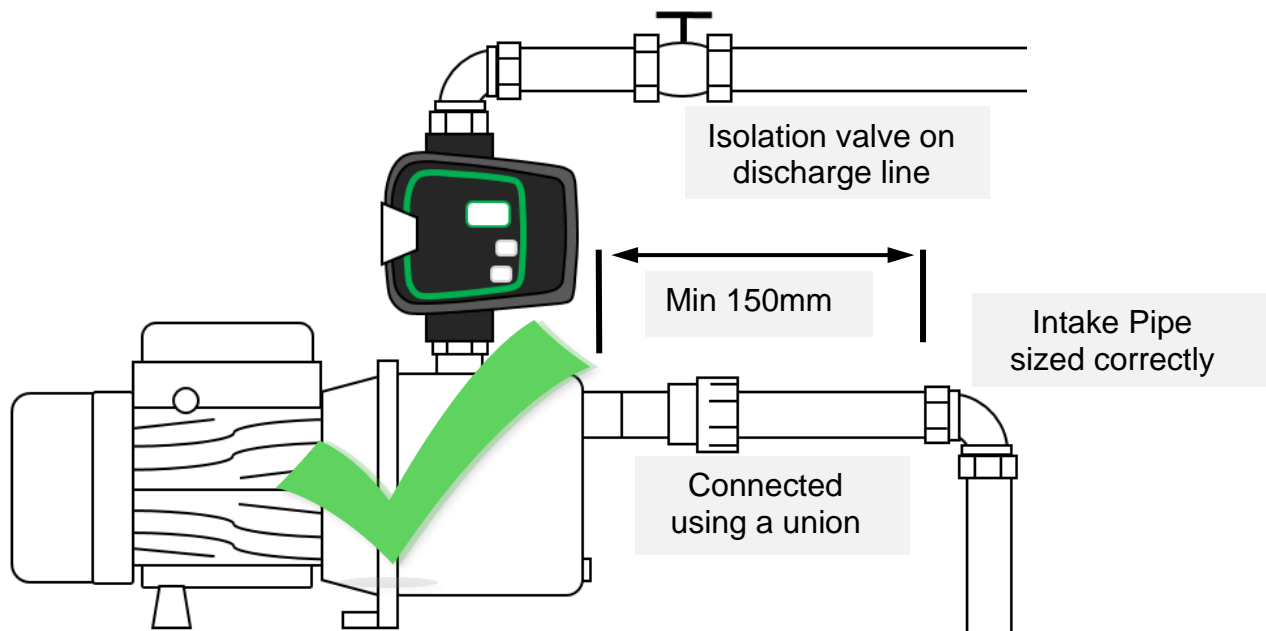
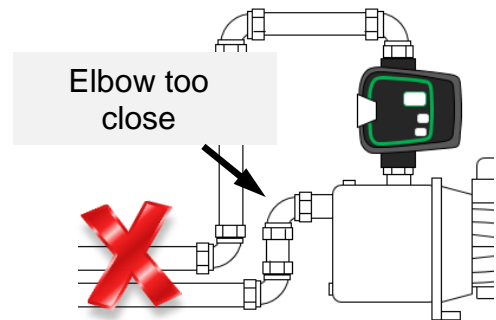
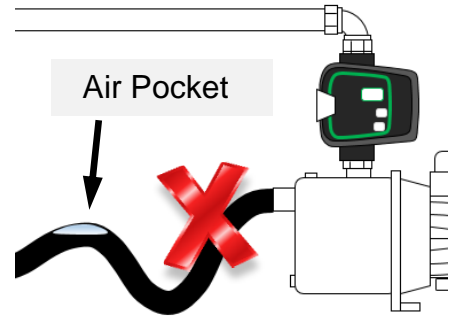

Optional: If the water is known to contain particles (sand etc.) an in-line strainer/filter can be fitted. Usually 500 micron is sufficient, Regular maintenance is required to keep an in-line strainer/filter clean and ensure best pump performance.

## 11. Boosting mains supply or connecting to a hot water system

### Boosting Mains supply

Connecting any of these pumps directly to mains water supply is not recommended.



If mains pressure is poor, best practice is to install an isolating (break) tank.

Use the guidelines in Section 12 or 13 depending whether the water from the tank will be above or below the pump inlet.

Note PTF models not recommended for suction lift applications.

### Pumps supplying Mains Pressure Hot Water Systems:

An approved Non Return Valve should be fitted to the hot water inlet to protect the pump from backpressure due to expansion.

### Pumps supplying Low Pressure Hot Water Systems:

Fit a pressure reducing valve to ensure pump maximum pressure doesn't exceed hot water cylinder rating.



Hot water systems must be installed in accordance with the manufacturer's recommendations and comply with all local regulations.



### Water column above controller

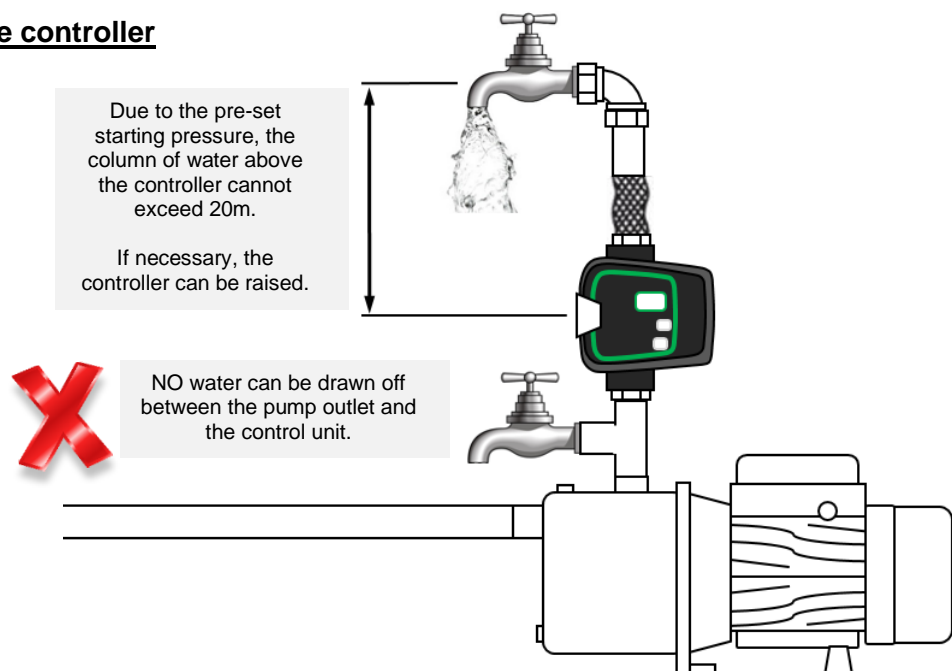

## 12. Water supply above the pump inlet (flooded suction)



Review SECTION 6 and 6.1 (Warnings and Cautions) prior to installation

### Reminders of best practice

Fit a valve to isolate the tank

If the suction line is quite long fit another valve close by the pump

Non Return Valve in suction line recommended

Avoid pipework which could trap air

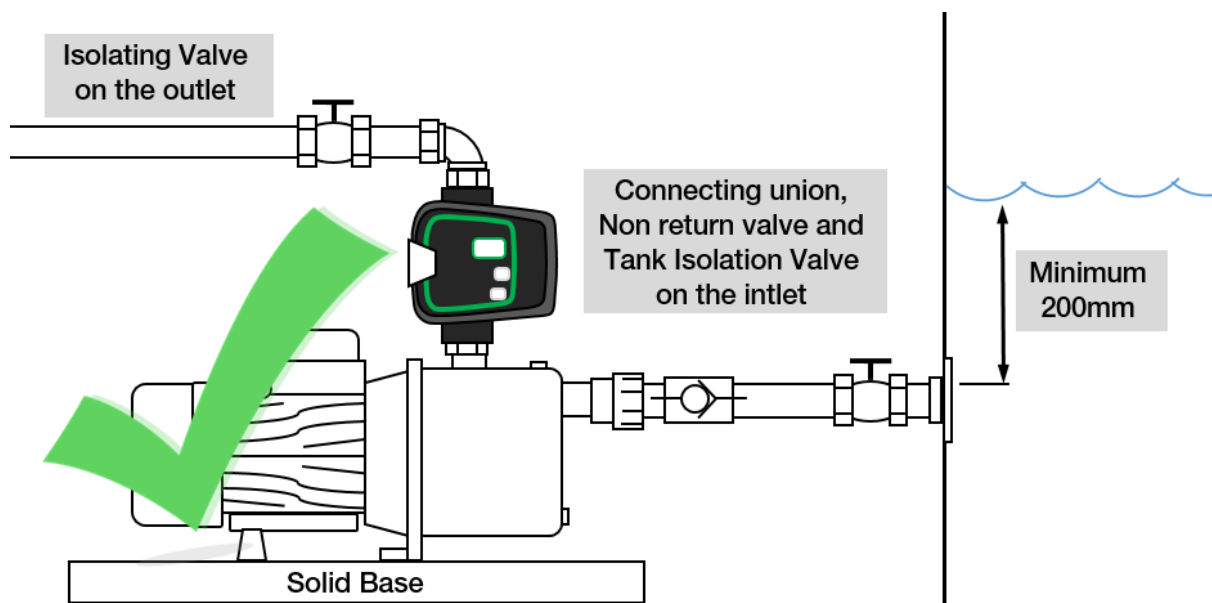

In this example the water level is above the pump inlet but the water cannot flow freely into the pump.

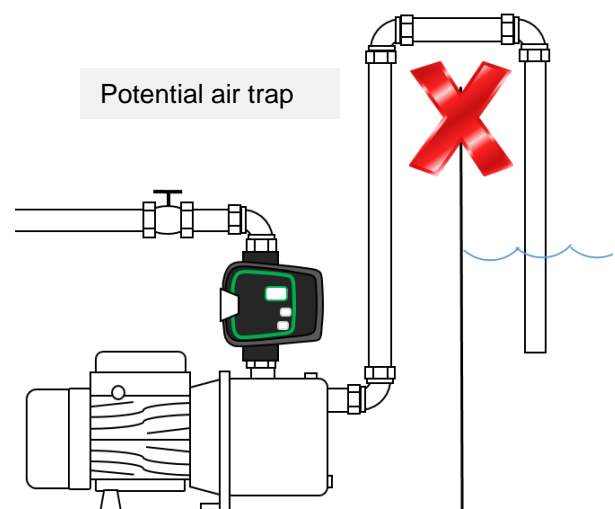

# 13. Water supply below the pump inlet (suction lift)

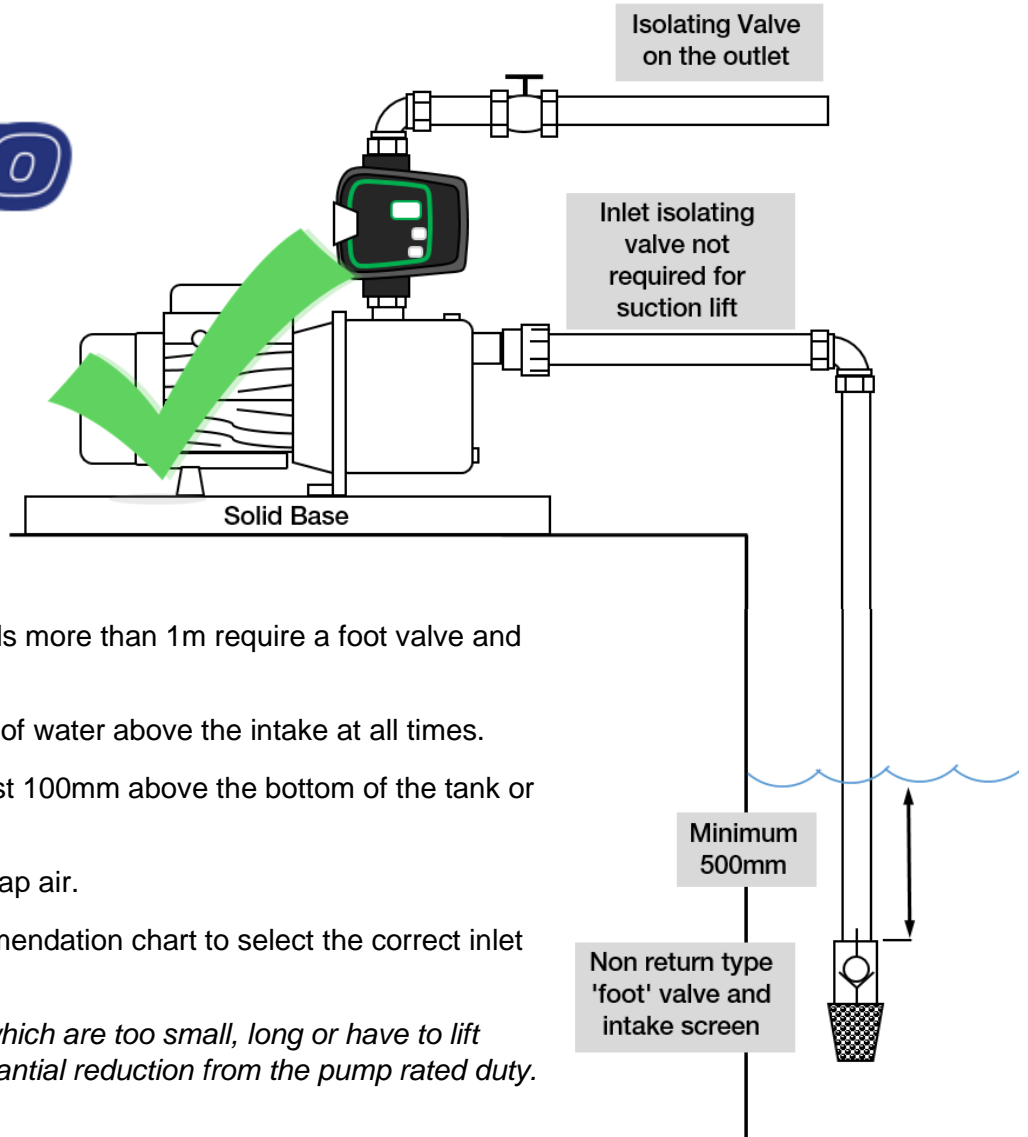

**PTF** not recommended for suction lift applications

### Reminders of best practice

Suction pipes drawing upwards more than 1m require a foot valve and an intake screen.

Ensure there is at least 300m of water above the intake at all times.

Keep the intake screen at least 100mm above the bottom of the tank or well

Avoid pipework which could trap air.

Use the Suction Pipe Recommendation chart to select the correct inlet pipe size.

*Note that intake pipes which are too small, long or have to lift significantly result in a substantial reduction from the pump rated duty.*

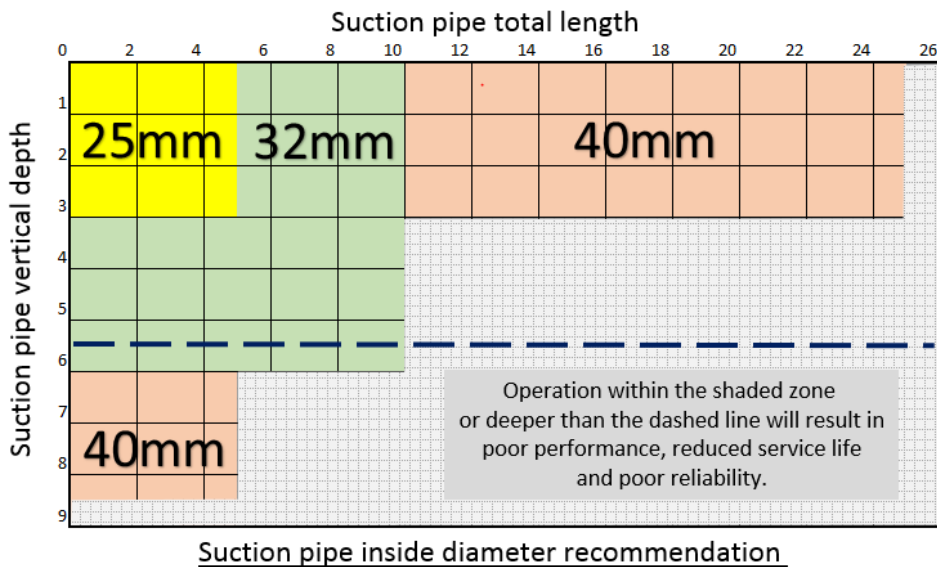

## 14. Priming and Operation

Bianco Inxo and Ferro pumps are “self-priming” but this still means that the pump and delivery line **MUST** be manually primed (filled) before the pump is started for the first time to ensure the mechanical seal is well lubricated. Dry operation causes irreparable damage to the mechanical seal.



**Never start a pump until the pump chamber is filled with water.**

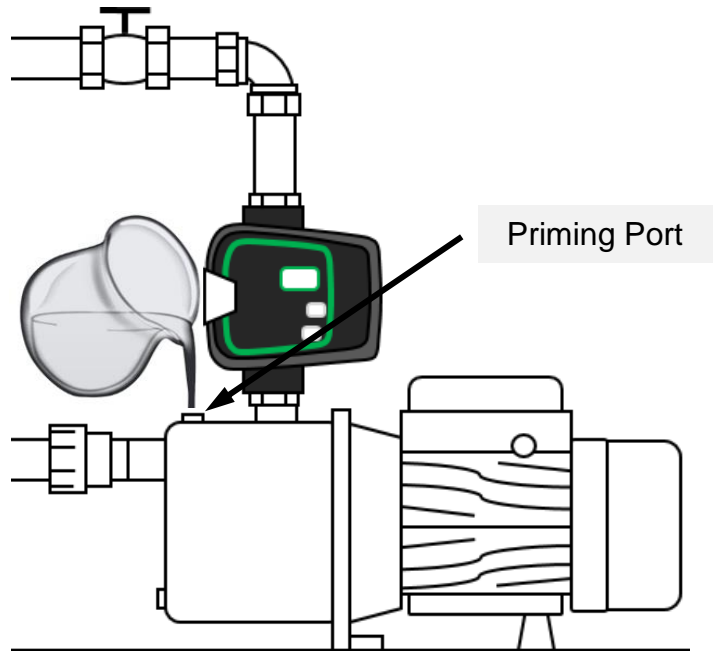

- 1 Ensure the pump power supply is disconnected.
- 2 Fill the pump body and suction line completely with clean water via the priming port or by removing the controller (see controller instructions)
- 3 Check that the motor fan blade rotates freely.
- 4 Ensure that the pump inlet line is fully submerged and that the pump will not draw any air into the system.
- 5 Connect to the power supply and start the pump with a tap open.

If no water comes out of discharge or there is only limited flow, disconnect the pump from the power source and refill the pump body. Reset the controller if it has shut down sensing ‘dry-run’. Check for any possible leaks in the pipework.

Restart the pump with a tap open.

- 6 Once primed satisfactorily, check that the pump switches off when the tap is closed.

## 15. Warranties – Terms and Conditions

This warranty is given in addition to the consumer guarantees found within the Australian Competition and Consumer Act 2010 (Cth) for goods purchased in Australia and the Consumer Guarantees Act 1993 NZ for goods purchased in New Zealand:



- 1) White International Pty Ltd / White International NZ Ltd (White International) warrant that all products distributed are free from defects in workmanship and materials, for their provided warranty period as indicated on the top or opposite side of this document. Subject to the conditions of the warranty, White International will repair any defective products free of charge at the premises of our authorised service agents throughout Australia and New Zealand if a defect in the product appears during the warranty period. If you believe that you have purchased a defective product and wish to make a claim under this warranty, contact us on our Sales Hotline on 1300 783 601, or send your claim to our postal address or fax line below and we will advise you as to how next to proceed. You will be required to supply a copy of your proof of purchase to make a claim under this warranty.
- 2) This warranty excludes transportation costs to and from White International or its appointed service agents and excludes defects due to non-compliance with installation instructions, neglect or misuse, inadequate protection against the elements, low voltage or use or operation for purposes other than those for which they were designed. For further information regarding the suitability of your intended application contact us on our Sales Hotline on 1300 783 601. If you make an invalid claim under this warranty, the original product will be sent back to you unrepaired.
- 3) This warranty refers only to products sold after the 1st January 2012, and is not transferable to another product type and only applies to the original owner, purchaser or end user, and is in addition to the consumer guarantees found within the Competition and Consumer Act 2010 (Cth) for goods purchased in Australia and the Consumer Guarantees Act 1993 (NZ) for goods purchased in New Zealand.
- 4) Our goods come with guarantees that cannot be excluded under the Australian Consumer Law. You are entitled to a replacement or refund for a major failure and for compensation for any other reasonably foreseeable loss or damage. You are also entitled to have the goods repaired or replaced if the goods fail to be of acceptable quality and the failure does not amount to a major failure. 2 YEAR WARRANTY
- 5) To the fullest extent permitted by law, White International excludes its liability for all other conditions or warranties which would or might otherwise be implied at law. To the fullest extent permitted by law, White International's liability under this warranty and any other conditions, guarantees or warranties at law that cannot be excluded, including those in the Competition and Consumer Act 2010 (Cth), is expressly limited to: (a) in the case of products, the replacement of the product or the supply of equivalent product, the payment of the cost of replacing the product or of acquiring an equivalent product or the repair of the product or payment of the cost of having the product repaired, is at the discretion of White International or a 3rd party tribunal elected under the Competition and Consumer Act 2010 (Cth) for goods purchased in Australia and the Consumer Guarantees Act 1993 (NZ) for goods purchased in New Zealand; and
- 6) To the fullest extent permitted by law, this warranty supersedes all other warranties attached to the product or its packaging.
- 7) In the case of services, supplying the services again or the payment of the cost of having the services supplied again, is at the discretion of White International or a 3rd party tribunal elected under the Competition and Consumer Act 2010 (Cth) for goods purchased in Australia and the Consumer Guarantees Act 1993 (NZ) for goods purchased in New Zealand. 8) Our warranty commences from the date of purchase of the above mentioned pumps. Proof of purchase is required before consideration under warranty is given.

*Record your date of purchase in the space below and retain this copy for your records.*

**Date of Purchase** .....**Model Purchased** .....

## 16. Trouble Shooting Guide

	POSSIBLE CAUSE	POTENTIAL SOLUTIONS
The pump won't start and makes no noise	<ol style="list-style-type: none"> <li>1. No electricity</li> <li>2. Fuses or RCD tripped</li> <li>3. Internal motor fault</li> <li>4. The static head pressure is greater than the cut in setting (applies when commissioning)</li> <li>5. Controller has sensed dry run and is its auto restart cycle (Failure light slowly flashing)</li> </ol>	<ol style="list-style-type: none"> <li>1. Check the power supply. Is the power LED on the controller illuminated?</li> <li>2. Fuses or RCD tripped may indicate more serious problems</li> <li>3. Contact an expert to check the motor</li> <li>4. Static water head above the controller must be less than 20m</li> <li>5. Press the controller reset button</li> </ol>
The pump doesn't start but makes a noise	<ol style="list-style-type: none"> <li>1. Motor not free to turn i.e. internal jamming</li> <li>2. Faulty capacitor</li> </ol>	<ol style="list-style-type: none"> <li>1. Check whether pump can rotate freely</li> <li>2. Contact an expert to check/replace capacitor</li> </ol>
The pump runs but there is no flow or only poor flow	<ol style="list-style-type: none"> <li>1. Valves closed</li> <li>2. Air entering suction line (loss of prime)</li> <li>3. The water level may be too low</li> <li>4. Pump may be worn or damaged</li> <li>5. Blockages in the pump, suction or discharge</li> <li>6. In-line filters blocked (if fitted)</li> <li>7. The piping may be too long or too small</li> </ol>	<ol style="list-style-type: none"> <li>1. Check suction and discharge isolating valves</li> <li>2. Check for leaks and ensure all joins or fittings are sealed</li> <li>3. Check water availability</li> <li>4. Contact your service agent for repair</li> <li>5. Contact your service agent for repair</li> <li>6. Clean any filters/strainers in the system</li> <li>7. Contact your pump professional</li> </ol>
The pump runs. There is flow but poor pressure	<ol style="list-style-type: none"> <li>1. Excessive flow demand</li> <li>2. Total head requirement too great for the pump</li> <li>3. Pump may be worn or damaged</li> <li>4. Air entering suction line reducing performance</li> </ol>	<ol style="list-style-type: none"> <li>1. Check that the pump selected is correct for the application</li> <li>2. Check the pump specification</li> <li>3. Contact your service agent</li> <li>4. Ensure the suction line is sealed correctly</li> </ol>
Pump cycling on and off	<ol style="list-style-type: none"> <li>1. Small water draw off or leak</li> <li>2. Leak in suction or discharge line</li> <li>3. Contamination in the controller</li> </ol>	<ol style="list-style-type: none"> <li>1. Check for small leaks i.e. taps or cistern</li> <li>2. Check for leaks including suction line non return valve</li> <li>3. Contact your service agent to inspect</li> </ol>
Pump runs intermittently	<ol style="list-style-type: none"> <li>1. Overheating and thermal protection tripping</li> </ol>	<ol style="list-style-type: none"> <li>1. Ensure the water temp is less than 40 deg C. Ensure sufficient airflow to cool the motor. <i>Note that low voltage can cause the motor to overheat.</i></li> </ol>
Pump vibrates and is noisy	<ol style="list-style-type: none"> <li>1. Incorrectly mounted/fixd</li> <li>2. Internal blockage causing impeller imbalance</li> <li>3. If the flow requirement is greater than the pump is capable of it will cavitate. <i>Cavitation sounds like gravel inside pump.</i></li> </ol>	<ol style="list-style-type: none"> <li>1. Ensure the pump is solidly attached to a base</li> <li>2. Contact your service agent</li> <li>3. Reduce the water demand to see if the noise disappears. Ensure the suction pipe is sized correctly A different pump model may be required Contact your service agent</li> </ol>
Water leaking from the centre of the pump	<ol style="list-style-type: none"> <li>1. The mechanical seal is leaking</li> </ol>	<ol style="list-style-type: none"> <li>1. Contact your service agent for repair</li> </ol>



**[www.whiteint.com.au](http://www.whiteint.com.au)**

**[www.whiteint.co.nz](http://www.whiteint.co.nz)**

**Please always refer to our website for further technical information & new product innovations**

**Disclaimer:** Every effort has been made to publish the correct information in this manual. No responsibility will be taken for errors, omissions or changes in product specifications.

© 2020 Copyright White International Pty Ltd

TM ® - WARNING: Please be aware that various brands & products depicted within this document are subject to trademark, patent or design registrations. Infringement of any intellectual property contained within this document without express written authority by the appropriate intellectual property holder may result in further legal action to be taken. For any queries regarding use of the contained information please feel free to contact White International Pty Ltd.